

# Mecanisme à Treuil

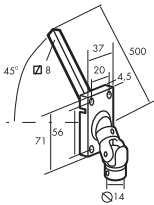

SORTIE CAISSON 45°  
P/AXE  
4 TROUS.

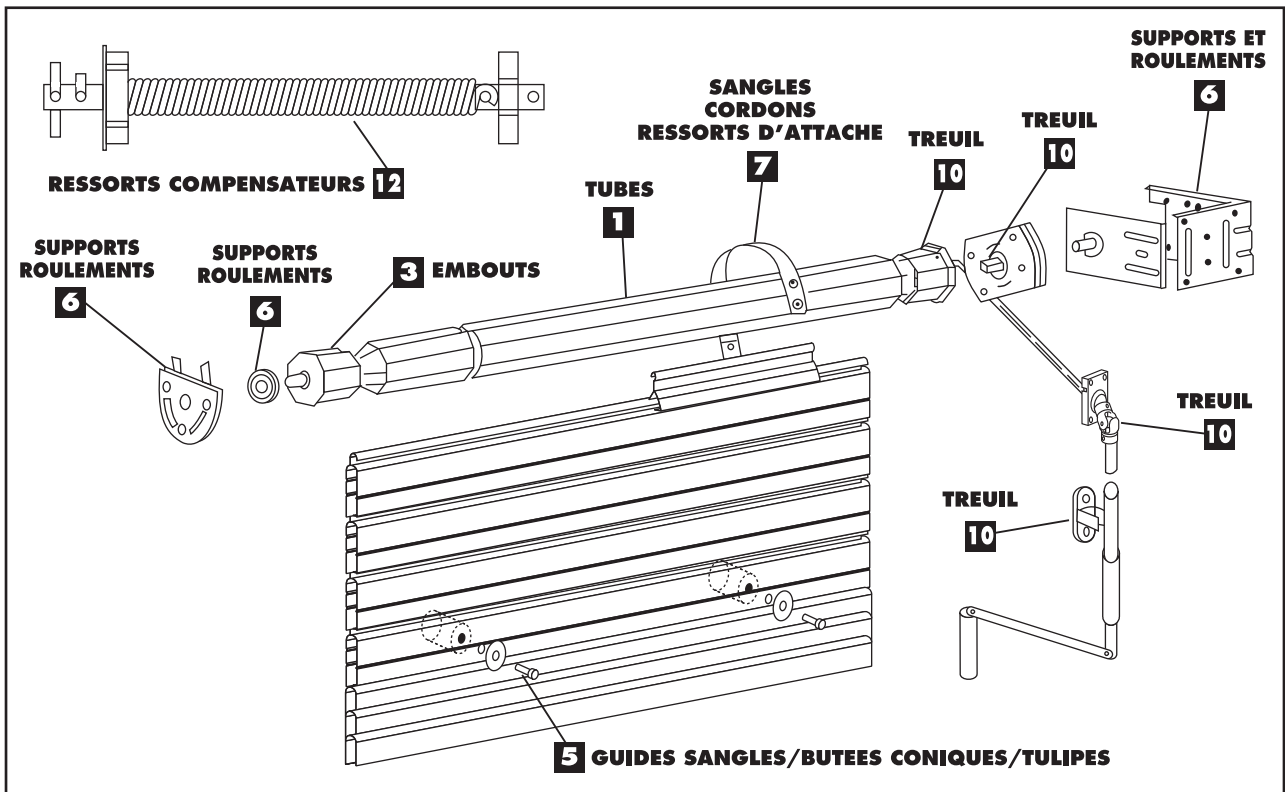
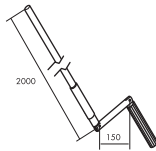

MANIVELLE TREUIL  
TUBE 2M DEMONTE.

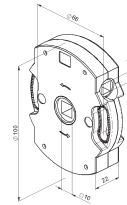

TREUIL ACE 1:11  
OCTOGONAL  
MAX. 30 KG  
AFC.

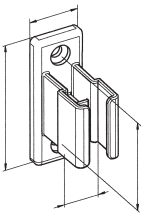

BLOQUEUR EN  
POLYAMIDE

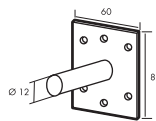

PLAQUE AVEC PIVOT  
POUR SUPPORT L.

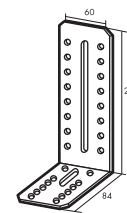

SUPPORT L TROUS  
LISSES.

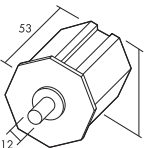

EMBOUT EN  
PLASTIQUE P-12

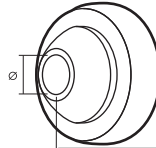

ROULEMENT 42X10.

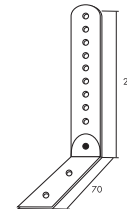

EQUERRE JAMBE  
DE FORCE.

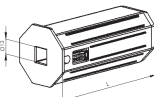

EMBOUT  
PLASTIQUE CLIP  
C-13.

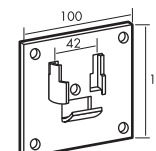

SUPPORT 100X100  
P/ROULEMENT 42MM.

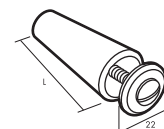

ARRET BOUCHON  
AVEC RONDELLE.